

## Description

The DL2804LS8 is designed to protect low voltage, CMOS semiconductors from transients caused by electrostatic discharge(ESD), cable discharge events(CDE), lightning and other induced voltage surges. Low capacitance compensation diode is integrated into the TVS to lower the typical capacitance to 6pF per line. The DL2804LS8 complies with the IEC 61000-4-2 (ESD) standard with  $\pm 30\text{kV}$  air and  $\pm 30\text{kV}$  contact discharge. The DL2804LS8 is assembled into a 8-pin lead-free SO-8 package. The combination of low leakage, signal integrity and flow through design makes the DL2804LS8 an ideal application such as 10/100/1000 Ethernet.

## Mechanical Characteristics

- ◆ Package: SO-8
- ◆ Lead Finish: Matte Tin
- ◆ Case Material: "Green" Molding Compound.
- ◆ UL Flammability Classification Rating 94V-0
- ◆ Moisture Sensitivity: Level 3 per J-STD-020
- ◆ Terminal Connections: See Diagram Below
- ◆ Marking Information: See Below

## Dimensions and Pin Configuration

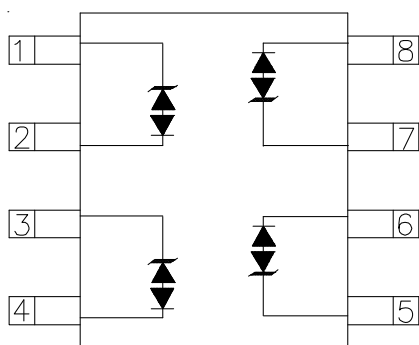

Circuit and Pin Schematic

## Features

- ◆ 100W peak pulse power(8/20 $\mu\text{s}$ )
- ◆ Protects two line pairs(four lines)
- ◆ Ultra low leakage: nA level
- ◆ Low operating voltage: 2.8V
- ◆ Low capacitance
- ◆ Ultra low clamping voltage
- ◆ JEDEC SO-8 package
- ◆ Complies with following standards:
  - IEC 61000-4-2 (ESD) immunity test
    - Air discharge:  $\pm 30\text{kV}$
    - Contact discharge:  $\pm 30\text{kV}$
  - IEC61000-4-4 (EFT) 40A (5/50ns)
  - IEC61000-4-5 (Lightning) 10A (8/20 $\mu\text{s}$ )
- ◆ RoHS Compliant

## Applications

- ◆ Base Station
- ◆ Analog Inputs
- ◆ Switch Systems
- ◆ 10/100/1000 Ethernet
- ◆ WAN/LAN Equipment
- ◆ Desktops, Servers, and Notebooks
- ◆ Low Voltage Interfaces

## Marking Information

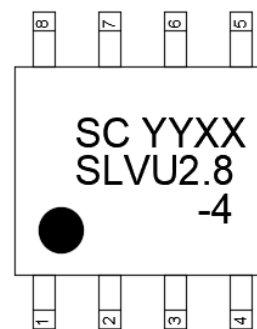

YYWW=Date Code  
Dot denotes Pin1

## Ordering Information

Part Number	Marking	Packaging	Reel Size
DL2804LS8	SLVU2.8-4	2500/Tape & Reel	13 inch

**Absolute Maximum Ratings ( $T_A=25^{\circ}\text{C}$  unless otherwise specified)**

Parameter	Symbol	Value	Unit
Peak Pulse Power (8/20 $\mu\text{s}$ )	Ppk	100	W
Peak Pulse Current (8/20 $\mu\text{s}$ )	I <sub>PP</sub>	10	A
ESD per IEC 61000-4-2 (Air)	V <sub>ESD</sub>	$\pm 30$	kV
ESD per IEC 61000-4-2 (Contact)		$\pm 30$	
Operating Temperature Range	T <sub>J</sub>	-55 to +125	$^{\circ}\text{C}$
Storage Temperature Range	T <sub>stg</sub>	-55 to +150	$^{\circ}\text{C}$

**Electrical Characteristics ( $T_A=25^{\circ}\text{C}$  unless otherwise specified)**

Parameter	Symbol	Min	Typ	Max	Unit	Test Condition
Reverse Working Voltage	V <sub>RWM</sub>			2.8	V	
Punch-Through Voltage	V <sub>PT</sub>	3.5	3.8		V	I <sub>T</sub> = 2 $\mu\text{A}$
Snap-Back Voltage	V <sub>SB</sub>	2.8			V	I <sub>T</sub> = 50mA
Reverse Leakage Current	I <sub>R</sub>			0.05	$\mu\text{A}$	V <sub>RWM</sub> = 2.8V
Clamping Voltage	V <sub>C</sub>			5.5	V	I <sub>PP</sub> = 1A (8 x 20 $\mu\text{s}$ pulse)
Clamping Voltage	V <sub>C</sub>			10	V	I <sub>PP</sub> = 10A (8 x 20 $\mu\text{s}$ pulse)
Variation in Capacitance With reverse bias			1.3		pF	Pin 1,8 to 2,7 and Pin 3,6 to 4,5 V <sub>R</sub> =0 to 2.8V f=1MHZ
Junction Capacitance	C <sub>J</sub>		4.5	6	pF	Pin 1,8 to 2,7 and Pin 3,6 to 4,5 V <sub>R</sub> =2.8V f=1MHZ

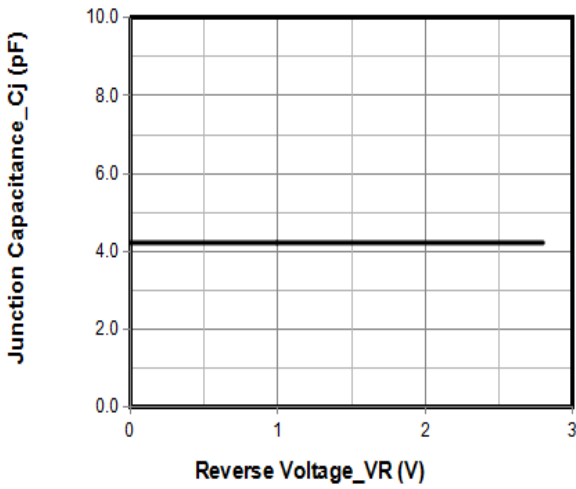

Junction Capacitance vs. Reverse Voltage

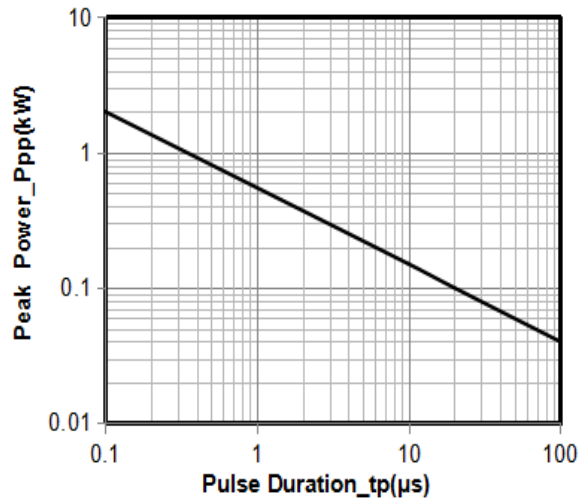

Peak Pulse Power vs. Pulse Time

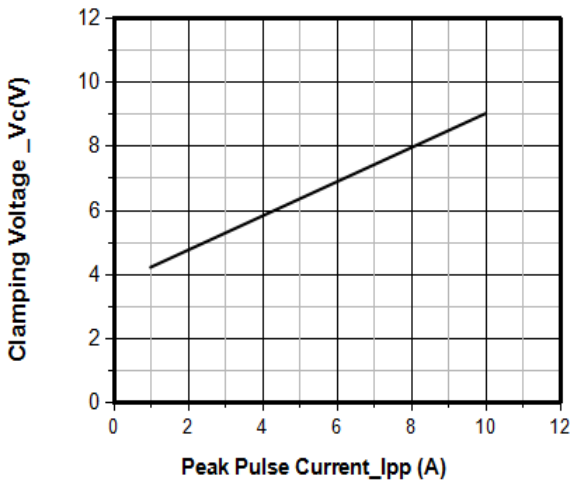

Power Derating Curve

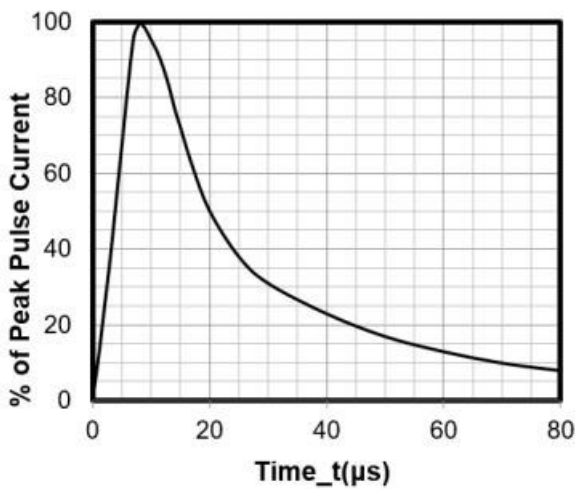
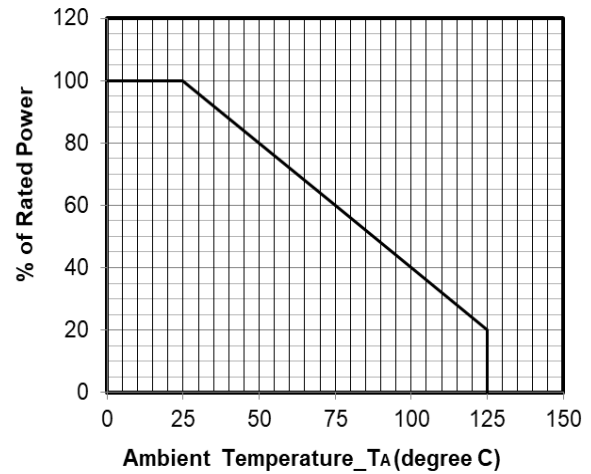

8 X 20μs Pulse Waveform

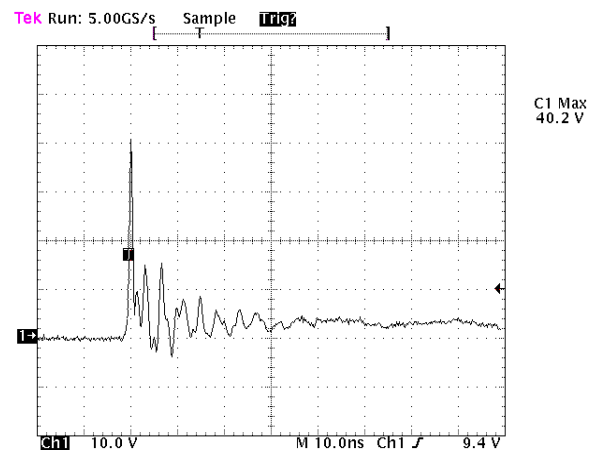

Note: Data is taken with a 10x attenuator

ESD Clamping Voltage

8 kV Contact per IEC61000-4-2

## SO-8 Package Outline Drawing

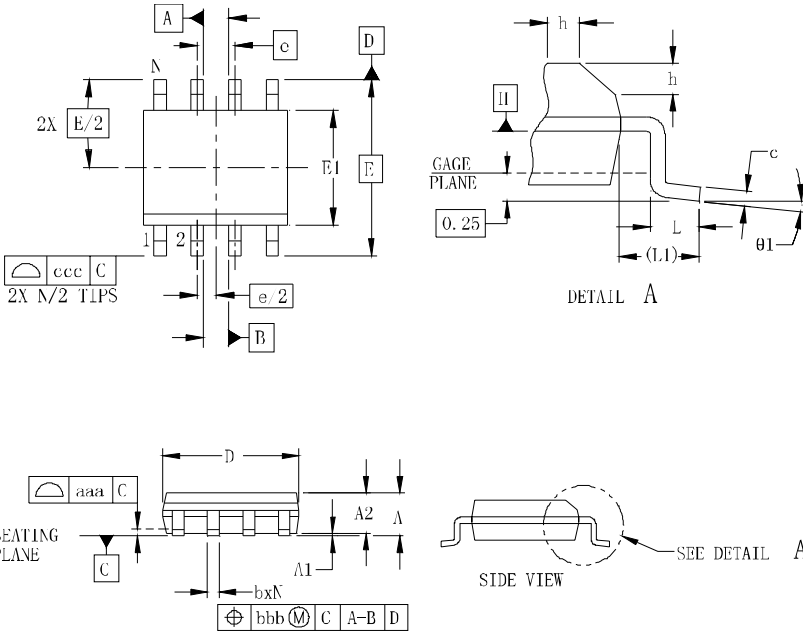

SYM	DIMENSIONS					
	MILLIMETERS			INCHES		
	MIN	NOM	MAX	MIN	NOM	MAX
A	1.35		1.75	0.053		0.069
A1	0.10		0.25	0.004		0.010
A2	1.25		1.65	0.049		0.065
b	0.31		0.51	0.012		0.020
c	0.17		0.25	0.007		0.010
D	4.80	4.90	5.00	0.189	0.193	0.197
E	3.80	3.90	4.00	0.150	0.154	0.157
E1	6.00 BSC			0.236 BSC		
e	1.27 BSC			0.050 BSC		
h	0.25		0.50	0.010		0.020
L	0.40	0.72	1.04	0.016	0.028	0.041
L1	(1.04)			(0.041)		
N	8			8		
theta1	0°		8°	0°		8°
aaa	0.10			0.004		
bbb	0.25			0.010		
ccc	0.20			0.008		

### Suggested

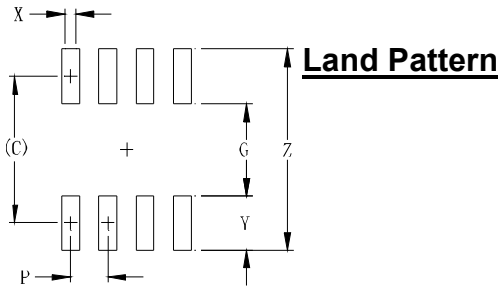

SYM	DIMENSIONS	
	MILLIMETERS	INCHES
C	(5.20)	0.205
G	3.00	0.118
P	1.27	0.050
X	0.60	0.024
Y	2.20	0.087
Z	7.40	0.291

## Contact Information

Changzhou D-first Electronics CO.,Ltd.  
 www.first-electronic.com  
 Email: xhf@first-electronic.cn  
 Phone: +86 (0519) 8817 1671